

Yealink

Smart Media Phone

SIP-T58V & SIP-T58A

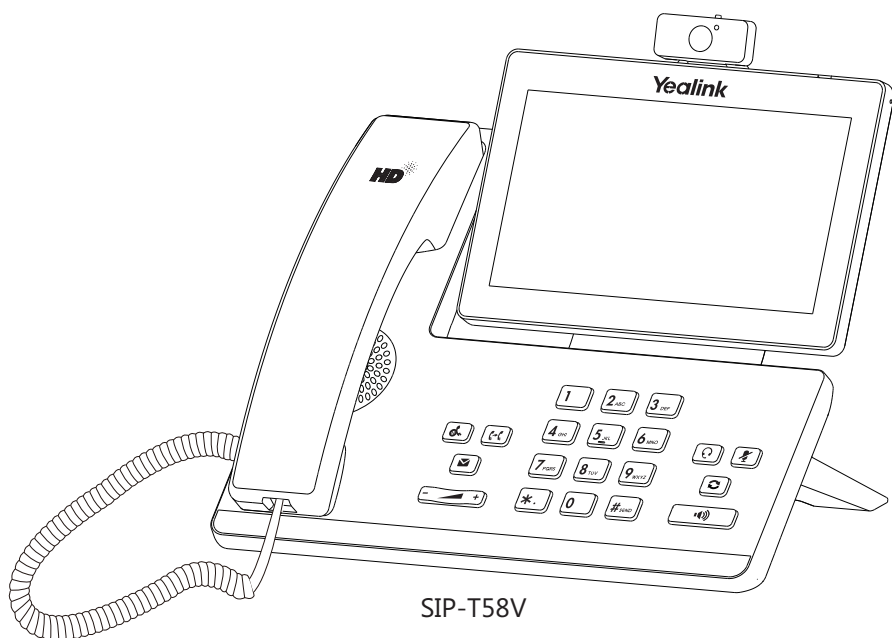

SIP-T58V

Quick Start Guide (V83.5)

Package Contents

The following items are included in your package. If you find anything missing, contact your system administrator.

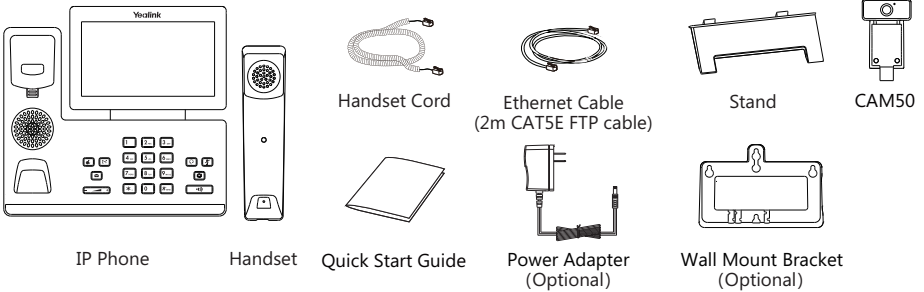

Note: The Yealink USB camera CAM50 is an optional accessory for the SIP-T58A IP phone. We recommend that you use the accessories provided or approved by Yealink. The use of unapproved third-party accessories may result in reduced performance.

Assembling the Phone

1. Insert the camera, as shown below:

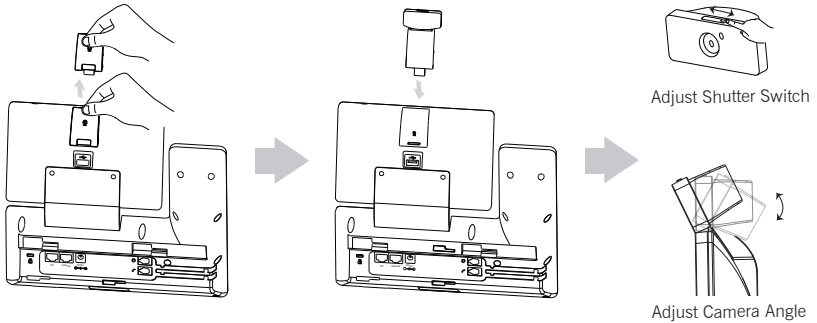

Note: The camera can only be connected to the USB port on the top of the phone. And the IP phone only supports the Yealink original USB camera CAM50.

2. Attach the stand and adjust the angle of touch screen, as shown below:

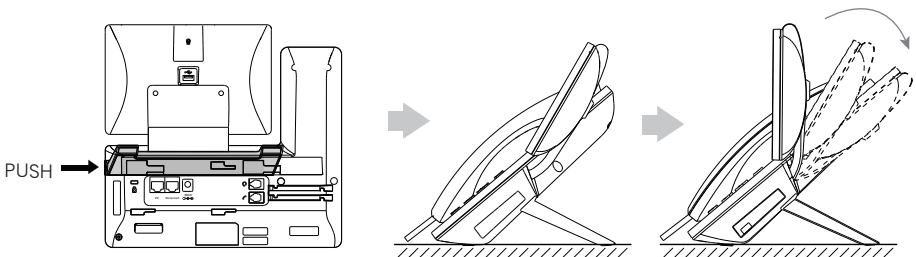

3. Attach the optional wall mount bracket, as shown below:

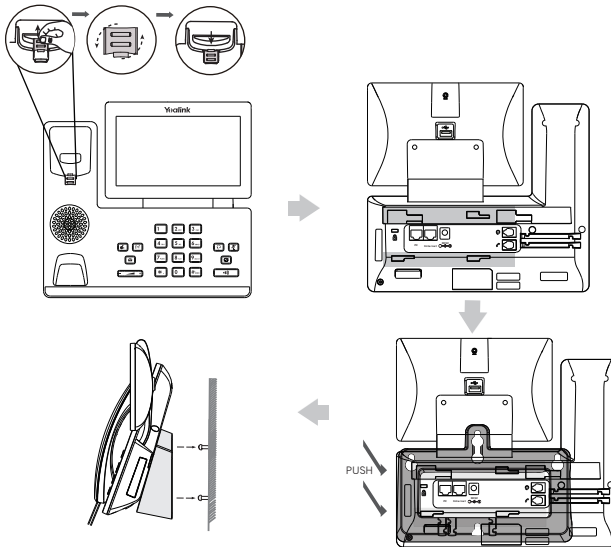

Note: The reversible tab has a lip which allows the handset to stay on-hook when the IP phone is mounted vertically. For more information, refer to Yealink Wall Mount Quick Installation Guide for Yealink IP Phones.

4. Connect the handset and optional headset, as shown below:

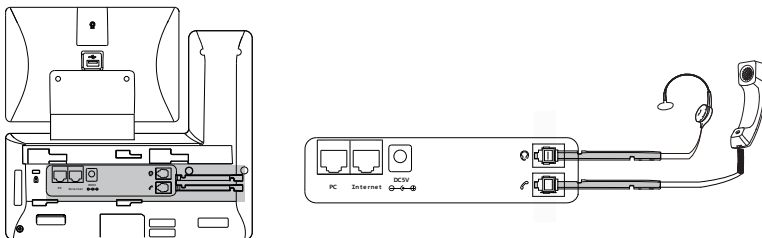

Note: The headset should be purchased separately.

5. Connect the optional USB flash drive, as shown below:

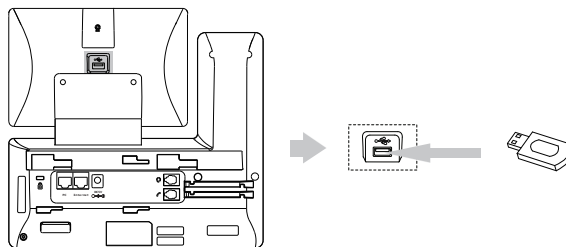

Note: The USB port (on the rear of the phone) can also be used to connect color-screen expansion module EXP50, USB headset or DECT dongle kit DD10K. For more information on how to use EXP50, refer to Yealink EXP50 User Guide. For more information on how to use USB headset, refer to the documentation from the manufacturer. For more information on how to use DD10K, refer to Yealink DECT Dongle Kit DD10K Quick Start Guide.

6. Connect the AC power or PoE, as shown below:

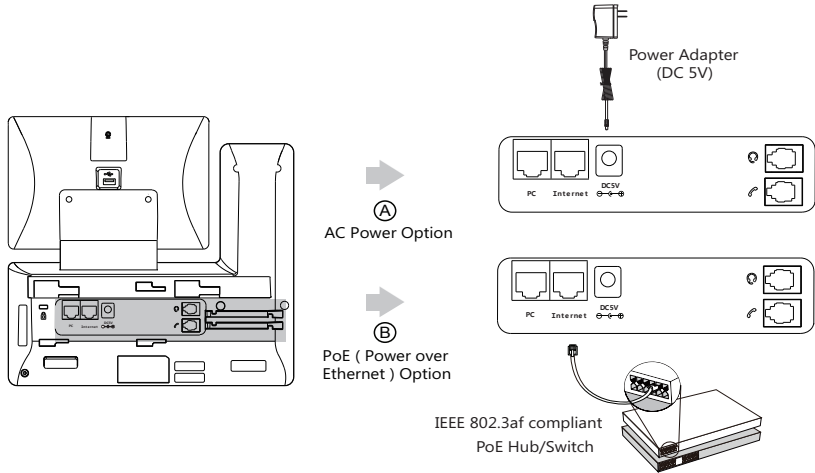

Note: The IP phone should be used with Yealink original power adapter (5V/2A) only. The use of the third-party power adapter may cause the damage to the phone.

7. Connect to the network, as shown below:

You have two options for network connection. You can select one of them according to the current office environment.

a) Connect to the wired network:

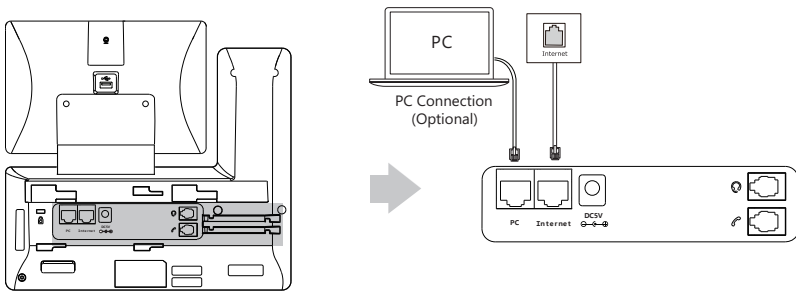

Note: If you are connecting a PC to your phone, we recommend that you use the Ethernet cable provided by Yealink.

b) Connect to the wireless network:

- 1) Swipe down from the top of the screen to enter the control center.
- 2) Tap **Setting**->**Basic**->**Wi-Fi**.
- 3) Tap the **On** radio box in the **Wi-Fi** field.
The phone will automatically search for available wireless networks in your area.
- 4) Select an available wireless network from the list of networks.
- 5) If the network is secure, enter its password in the **Password** field.
- 6) Tap **Connect** to connect to the wireless network.

Hardware Component Instructions

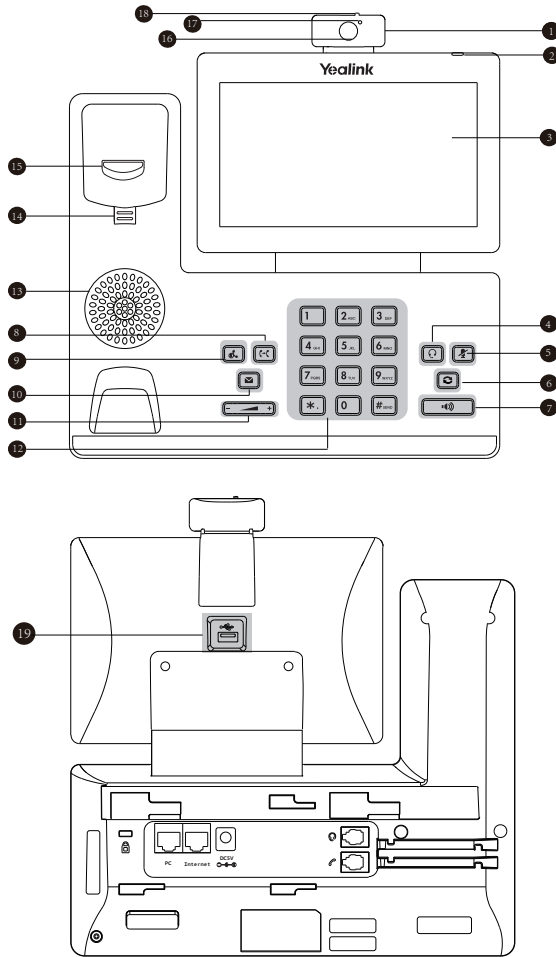

Item	Item	Item
1 Camera	8 TRANSFER Key	15 Hookswitch
2 Power Indicator LED	9 HOLD Key	16 Camera Lens
3 Touch Screen	10 MESSAGE Key	17 Camera Indicator LED
4 HEADSET Key	11 Volume Key	18 Shutter Switch
5 MUTE Key	12 Keypad	19 USB2.0 port
6 REDIAL Key	13 Speaker	
7 Speakerphone Key	14 Reversible Tab	

Startup

After the IP phone is connected to the network and supplied with power, it automatically begins the initialization process. After startup, the phone is ready for use. You can configure the phone via web user interface or phone user interface.

Welcome

initializing... Please wait

Configuring Your Phone

Configuring via web user interface

Accessing the web user interface:

1. Swipe down from the top of the screen to enter the control center.
2. Tap **Setting**->**Status** to obtain the IP address of the phone.
3. Open a web browser on your computer, enter the IP address into the address bar (e.g., "http://192.168.0.10" or "192.168.0.10"), and then press **Enter**.
4. Enter the user name (default: admin) and password (default: admin) in the login page and click **Confirm**.

Network Settings: Click on **Network**->**Basic**->**IPv4 Config**

You can configure the network settings in the following ways:

DHCP: By default, the phone attempts to contact a DHCP server in your network to obtain its valid network settings, e.g., IP address, subnet mask, gateway address and DNS address.

Static IP Address: If the phone cannot contact a DHCP server for any reason, you need to configure IP address, subnet mask, gateway address, primary DNS address and secondary DNS address for the phone manually.

PPPoE: If you are using an xDSL modem, you can connect your phone to the Internet via PPPoE mode. Contact the ITSP for the PPPoE user name and password.

Note: The IP phone also supports IPv6, but IPv6 is disabled by default.

The wrong network settings may result in inaccessibility of your phone and may have an impact on the network performance. Contact your system administrator for more information.

Account Settings: Click on **Account**->**Register**->**Account X** (X=1,2,3...15,16)

Parameters of the account:

Register Status:	It shows the register status of the current account.
Line Active:	You can select Enabled/Disabled to enable/disable the account.
Label:	It is shown on the touch screen to identify the account.
Display Name:	It is shown as Caller ID when placing a call.
Register Name:	It is an authenticated ID for authentication provided by ITSP (required).
User Name:	It is provided by ITSP for registration (required).
Password:	It is provided by ITSP for registration (required).
Server Host:	It is provided by ITSP for registration (required).

Register status icons on the touch screen:

 (Green) Registered

 (Gray) Register Failed

 (Green and Flashing) Registering

Note: Check with your system administrator if any error appears during the registration process or a specific configuration is required for your registration.

Configuring via phone user interface

Network Settings:

1. Swipe down from the top of the screen to enter the control center.
2. Tap **Setting**->**Advanced Settings** (default password: admin)->**Network**->**WAN Port/VLAN /Web Server/802.1x/VPN/LLDP/CDP/NAT** to configure the network.















Account Settings:

1. Swipe down from the top of the screen to enter the control center.
2. Tap **Setting**->**Advanced Settings** (default password: admin)->**Accounts** to configure the account.

Using Your Phone

Status Icons

The icons on the status bar of the touch screen give information about phone:

Icons	Description
	Shows that camera is not detected.
 (White)	Shows that Wi-Fi is turned on.
 (Green)	Shows that the phone is connected to wireless network successfully.
	Shows that wired network is unavailable.
 (White)	Shows that Bluetooth is turned on.
 (Green)	Shows that Bluetooth headset is paired successfully.
 (Green)	Shows that Bluetooth-Enabled mobile phone is paired successfully.
	Shows that the phone is locked.
	Shows that "Forward" is turned on.
	Shows that "Do Not Disturb" is turned on.
	Shows that "Auto Answer" is turned on.
	Shows that you have missed calls.
	Shows that you have unread voice mails.
	Shows that "Silent" is turned on.
	Shows that a USB flash drive is detected.

Using the Touch Screen

By default, the IP phone supports three idle screens. The home screen displays as below:



To navigate the touch screen:

- Swipe left or right to switch among different idle screens.
- Tap ◀ to go back to the previous screen.
- Tap ○ to return to the idle screen.
- Tap □ to view and manage recently used applications.

To change the wallpaper:

1. Long tap the empty spot on the idle screen.
2. Tap **WALLPAPERS**.
3. Select a desired picture.
4. Tap **Set wallpaper**.

To add a widget to the idle screen:

1. Long tap the empty spot on the idle screen.
2. Tap **WIDGETS**.
3. Drag the desired widget up/down/left/right to the destination spot on the idle screen.

Control Center and Notification Center

Swipe down from the top of the screen to enter the control center and the notification center.

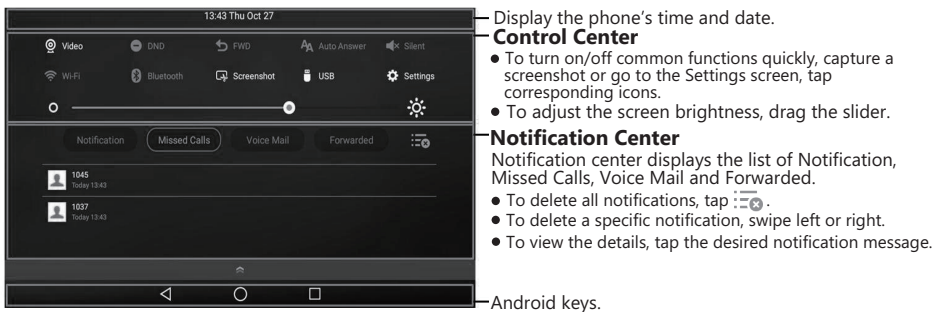

Display the phone's time and date.

Control Center

- To turn on/off common functions quickly, capture a screenshot or go to the Settings screen, tap corresponding icons.
- To adjust the screen brightness, drag the slider.

Notification Center

Notification center displays the list of Notification, Missed Calls, Voice Mail and Forwarded.

- To delete all notifications, tap .
- To delete a specific notification, swipe left or right.
- To view the details, tap the desired notification message.

Swipe up from the bottom of the screen to hide this screen.

Entering and Updating Data

To use onscreen keyboard:

1. Tap the input field, the onscreen keyboard will display on the touch screen:



Tap to access input options to configure Input Languages or Android Keyboard Settings(AOSP).

2. When you finish entering, tap  to hide the onscreen keyboard.

To use keypad:

Dial or enter number.

To select a field option:

Tap the field name, tap the desired option in the pop-up dialog box.

Basic Call Features

Placing a Video/Voice Call

Using the handset:

1. Pick up the handset.
2. Enter the number, and then tap **Send**.

Using the speakerphone:

1. With the handset on-hook, press .
2. Enter the number, and then tap **Send**.

Using the headset:

1. With the headset connected, press  to activate the headset mode.
2. Enter the number, and then tap **Send**.

Answering a Video/Voice Call

Using the handset:

Pick up the handset.

Using the speakerphone:

Press .

Using the headset:

Press .

Controlling Video During a Call

To change the video view:

- Tap **Full Screen** to display the video in full screen.
- Tap  to return.

To turn on/off near-site video during a call:

Swipe down from the top of the screen to enter the control center, tap **Video** to turn on/off the near-site video.

Ending a Video/Voice Call

Using the handset:

Hang up the handset or tap the **End Call** soft key.



Using the speakerphone:

Press  or tap the **End Call** soft key.



Using the headset:

Tap the **End Call** soft key.

Redial

- Press  to enter the **Placed Calls** list, and then tap the desired entry.
- Press  twice when the phone is idle to dial out the last dialed number.

Call Mute and Un-mute



- Press  to mute the microphone during a call.
- Press  again to un-mute the call.

Call Hold and Resume

To place a call on hold:

Press  or tap the **Hold** soft key during an active call.



To resume the call, do one of the following:

- If there is only one call on hold, press  or tap the **Resume** soft key.
- If there is more than one call on hold, tap the call you want to resume, and press  or tap the **Resume** soft key.



Call Transfer

You can transfer a call in the following ways:



Blind Transfer

1. Press  or tap the **Transfer** soft key during a call. The call is placed on hold.
2. Enter the number you want to transfer to.
3. Press .

Semi-Attended Transfer

1. Press  or tap the **Transfer** soft key during a call. The call is placed on hold.
2. Enter the number you want to transfer to, and then press .
3. Press  or tap the **Transfer** soft key when you hear the ring-back tone.

Attended Transfer

1. Press  or tap the **Transfer** soft key during a call. The call is placed on hold.
2. Enter the number you want to transfer to, and then press .
3. Press  or tap the **Transfer** soft key when the second party answers.

Call Forward

To enable call forward:

1. Swipe down from the top of the screen to enter the control center.
2. Tap **Settings**->**Features**->**Call Forward**.
3. Select the desired forward type:
 - Always Forward**----Incoming calls are forwarded unconditionally.
 - Busy Forward**----Incoming calls are forwarded when the phone is busy.
 - No Answer Forward**----Incoming calls are forwarded if not answered after a period of time.
4. Enter the number you want to forward to. For **No Answer Forward**, tap the **After Ring Time** field, and then tap the desired ring time to wait before forwarding.
5. Tap  to accept the change.

Call Conference

1. Tap the **Conference** soft key during an active call. The call is placed on hold.
2. Enter the number of the second party, and then press  or tap **Conference**.
3. Tap the **Conference** soft key again when the second party answers. All parties are now joined in the conference.
4. Tap the **End Call** soft key to disconnect all parties.

Note: You can split the conference call into two individual calls by tapping the **Split** soft key.

Voice Message



Message waiting indicator on the idle screen indicates that one or more voice messages are waiting at the message center. The power indicator LED slowly flashes red.

To listen to voice messages: (Ensure the voice mail code is already configured on the phone.)

1. Do one of the following:
 - Press .
 - Swipe down from the top of the screen to enter the notification center, tap **Voice Mail** and then select the desired item.
2. Follow the voice prompts to listen to your voice messages.



Customizing Your Phone

Call History



1. Tap , and then select the desired call list on the left.
2. Drag up and down to scroll.
3. Tap  after the desired entry, and then you can do the following:
 - Tap **Send** to place a call.
 - Tap **Add** to add the entry to the local directory.
 - Tap **Edit** to edit the phone number of the entry before placing a call.
 - Tap **Blacklist** to add the entry to the blacklist.
 - Tap **Delete** to delete the entry from the list.

Contact Directory



To add a contact:

1. Tap , and then select the desired group on the left.
2. Tap  to add a contact.
3. Enter a unique contact name in the **Name** field and contact numbers in the corresponding fields.
4. Tap  to accept the change.

To edit a contact:



1. Tap , and then select the desired group on the left.
2. Tap  after the desired contact.
3. Edit the contact information.
4. Tap  to accept the change.

To delete a contact:

1. Tap , and then select the desired group on the left.
2. Tap  after the desired contact and then tap **Delete**.
3. Tap **OK** when the touch screen prompts "Delete selected item?".

Note: You can add contacts from call history easily. For more information, refer to **Call History** above.

Volume Adjustment

- Press  during a call to adjust the receiver volume of the handset/speakerphone/headset.
- Press  when the phone is idle or ringing to adjust the ringer volume.
- Press  to adjust the media volume in the corresponding screen.

About Yealink

Yealink is a global leading provider of enterprise communication and collaboration solutions, offering video conferencing service to worldwide enterprises. Focusing on research and development, Yealink also insists on innovation and creation. With the outstanding technical patents of cloud computing , audio, video and image processing technology, Yealink has built up a panoramic collaboration solution of audio and video conferencing by merging its cloud services with a series of endpoints products. As one of the best providers in more than 140 countries and regions including the US, the UK and Australia, Yealink ranks No.1 in the global market share of SIP phones shipments.

Technical Support

Visit Yealink WIKI (<http://support.yealink.com/>) for the latest firmware, guides, FAQ, Product documents, and more. For better service, we sincerely recommend you to use Yealink Ticketing system (<https://ticket.yealink.com>) to submit all your technical issues.



T58V/T58A-EN

YEALINK(XIAMEN) NETWORK TECHNOLOGY CO.,LTD.
Web: www.yealink.com
Addr: 309, 3rd Floor, No.16, Yun Ding North Road, Huli
District, Xiamen City, Fujian, P.R. China
Copyright©2018 YEALINK(XIAMEN) NETWORK
TECHNOLOGY CO.,LTD.All rights reserved.